

Top View

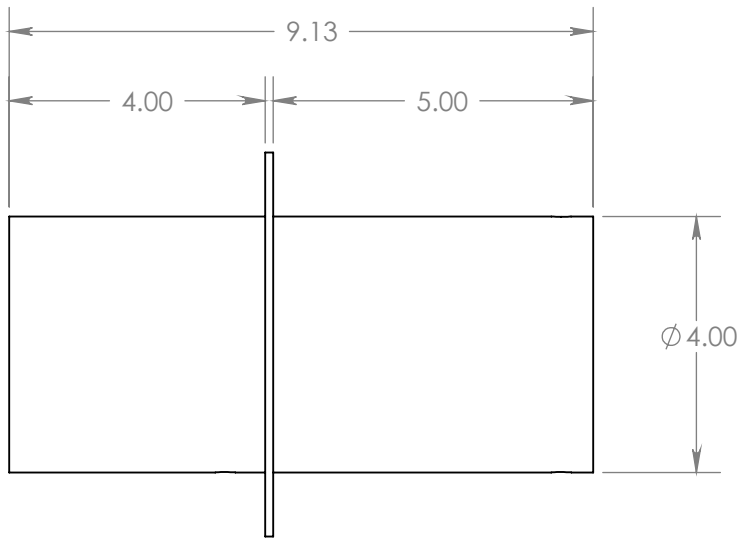

Side View

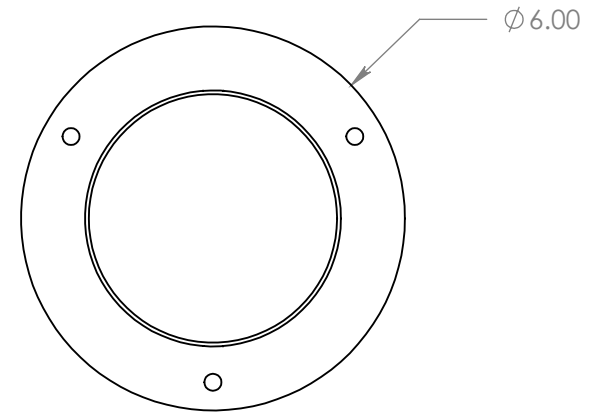
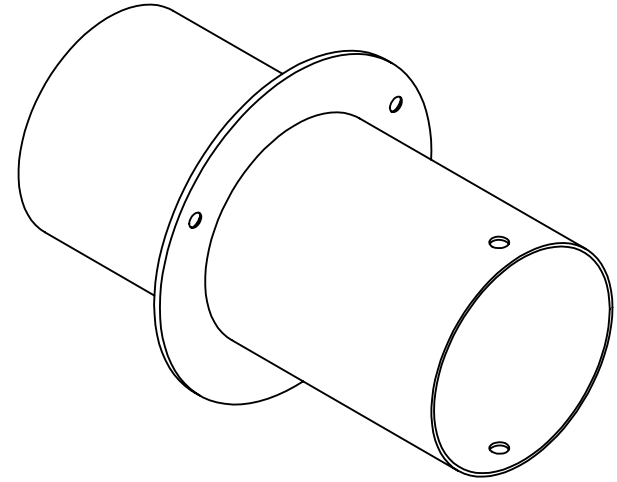

Rear View

UNLESS OTHERWISE SPECIFIED DIMENSIONS ARE IN INCHES. TOLERANCES ARE:		IMCO	
DECIMALS .XXX ±.005	ANGLES .XX ±1°	4" STRAIGHT CUT	
MATERIAL S/S	DATE 8/22/11	DWG. NO. 02-6336	REV. A
FINISH Polished	DRAWN RT	CAD FILE: 02-6336	SHEET 1 OF 1